

owner's manual



ORION *series*

**shademaker**  
architectural shade

## **WARRANTY:**

Upon receipt of your Orion, please check to ensure you have received all of the parts.

**NOTE: Wind damage is not covered under any manufacturer's warranty.**

**5 Year Limited Warranty includes the LIBRA, ASTRAL-TC, SIRIUS, POLARIS, ORION and GALAXY styles.** This includes the mast, boom, head fitting, elbow, center pole/sidepost, arms, ribs, top and bottom hub, and stainless steel hardware only. If there is damage under the warranty, Shademaker will replace and/or repair any item listed in this category at its discretion. Labor charges are not covered under this limited warranty.

**10 Year Limited Warranty includes the Sunbrella® awning & marine grade Fabric Collection.** Visit [www.sunbrella.com/warranty](http://www.sunbrella.com/warranty) for more details. Labor charges are not covered under this limited warranty.

**5 Year Limited Warranty applies to Sunbrella Firesist®, Sunbrella Firesist® PLUS and Sunbrella® furniture grade, and O'bravia® awning grade fabrics.** Labor charges are not covered under this limited warranty.

**1 Year Limited Warranty covers base wheels and the powder coat finish on all bases.** If the powder coat finish flakes, bubbles, peels or loses color; Shademaker will re-finish or replace the defective bases at its discretion. Normal wear and tear is not covered under this limited warranty. Labor charges are not covered under this limited warranty.

**Caution:** Seaside and indoor pool use, salt & chlorides can accumulate on the powder coat finish, leading to finish failure. Failure or neglect to make needed cleanings may cause paint to blister, and such failure will void limited warranty.

**Exclusions:** Wind damage, acts of nature (such as, but not limited to, freezing or any type of extreme weather). Failures caused by abusive use and normal wear and tear are not covered under this warranty. Any Galaxy style that does not have spacer buttons installed.

Parts can be ordered under warranty at no charge, if found that the damage is a manufacture defect and/or purchased out of warranty to make them whole again.

### **IMPORTANT RESTRICTION FOR SM PRODUCTS WARRANTY SERVICE:**

Shademaker restricts warranty service for SM products to the country where Shademaker or its authorized SM retail Dealers originally sold the product.

Those filing warranty claims will be responsible for all shipping, handling and freight charges on all claims to Shademaker in Baldwin Park, CA. All warranty claims must be submitted with the original proof of purchase, date of purchase, name of dealer and the description of the damage. An authorized Shademaker RA# must be listed on all products being returned. The Shademaker warranty is not transferable. Shademaker reserves the right to repair, replace and/or redesign any product that is returned under a warranty claim.

For current warranty information, please visit [www.shademakerusa.com](http://www.shademakerusa.com).

**IMPORTANT:**

**Please read this entire manual before installing or operating your Orion umbrella.**

**ORION WIND RESISTANCE GUIDELINES:**

Moderate to Moderately Strong Winds (when mounted)

When installed properly, the Orion is engineered to handle moderate to moderately strong wind conditions in the open canopy position. Please adhere to these wind guidelines:

1. As winds get stronger, or in anticipation of uncertain/severe weather conditions, the canopy should be lowered to the folded and strapped position.
2. The Orion should always be left in the folded and strapped position when unattended or not in use.
3. In anticipation of, and during extremely severe weather conditions, it is advisable to remove and store the Orion to protect it from storm-related debris.

**SPECIFICATIONS**

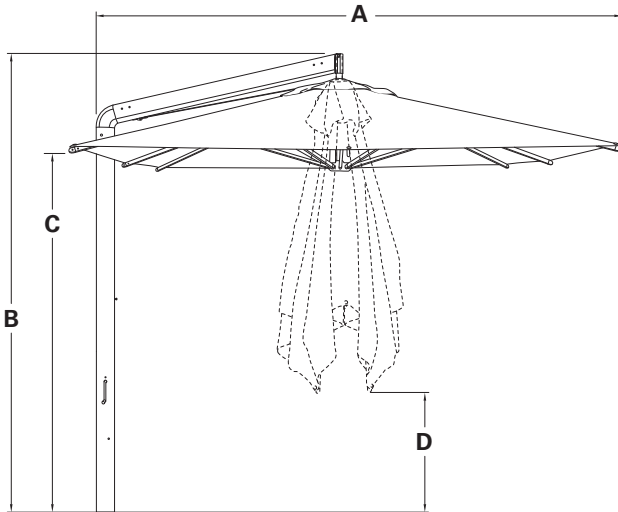

Item No.	A Mast End to Canopy Edge (Open)	B Overall Height	C Arm End Height (Open)	D Arm End Height (Closed)
OR-27S	9'6"	9'3"	6'9"	2'4"
OR-30S	10'6"	9'7"	6'11"	1'9"
OR-30	9'4"	8'11"	7'	3'6"
OR-35	11'4"	9'4"	7'4"	2'9"
OR-40	12'3"	9'10"	7'4"	2'6"

Weight: Approximately 78-103 lbs.  
Mast Shape & Diameter: 2.68" x 4.276" Oval  
Mast Thickness: 0.118"  
Rib Thickness: 0.051"

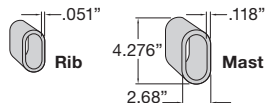

# DIAGRAM & PARTS LIST

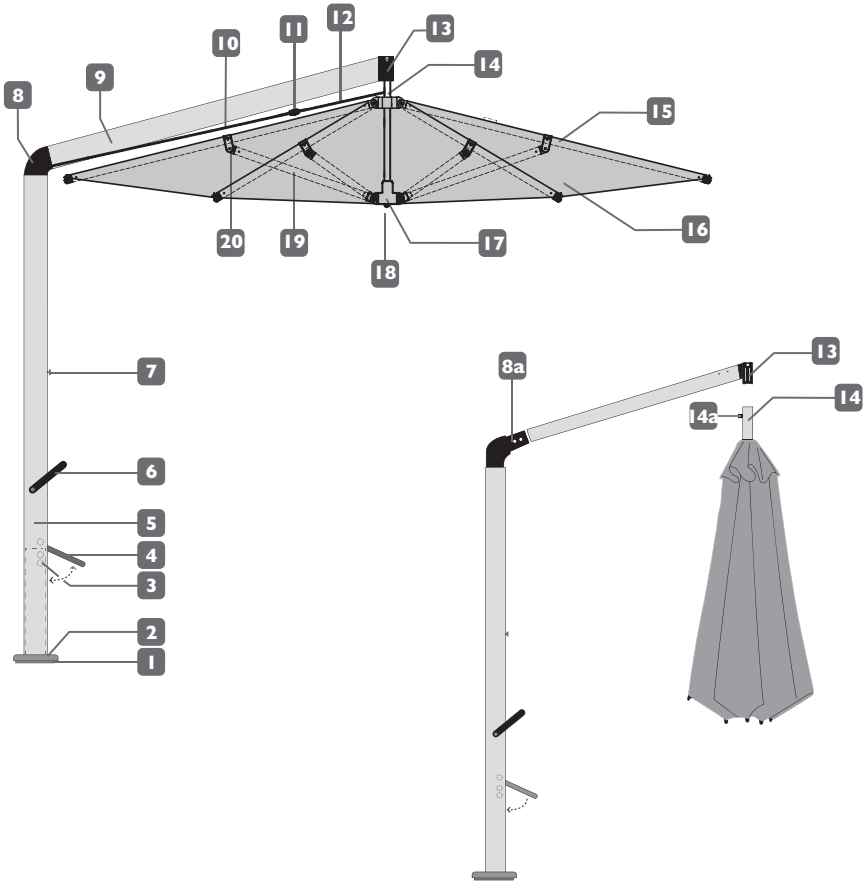

- |                                   |                      |                           |
|-----------------------------------|----------------------|---------------------------|
| 1. Internal Stem                  | 8. Elbow             | 14. Canopy Structure Pole |
| 2. Internal Stem Cover (optional) | 8a. Fastening Screws | 14a. Suspension Bolt      |
| 3. Bore Holes                     | 9. Boom              | 15. Arm                   |
| 4. Turning Handle                 | 10. Rope             | 16. Canopy                |
| 5. Mast                           | 11. Sister Clip      | 17. Lower Hub             |
| 6. Crank Handle                   | 12. Stainless Wire   | 18. Light Adapter         |
| 7. Safety Bolt for Sister Clip    | 13. Head Fitting     | 19. Strut                 |
|                                   |                      | 20. Strop                 |

## **INSTALLATION OPTIONS AND GUIDELINES**

There are four standard installation options which provide the best stability for the Orion. Depending on your situation, you will have requested one or more of the Orion base options at the time of your order.

- 1. CONCRETE MOUNT KIT** - This kit includes a base plate, four (4) plate bolts, and one (1) allen wrench.
- 2. IN-GROUND MOUNT KIT** - This kit includes in-ground fitting, four (4) plate bolts, and one (1) allen wrench.
- 3. STEEL BASE WEIGHT** - 213 lbs. Square steel base weight is available (SM PLATE required). We recommend a minimum of 400-600 lbs. of steel base weights for this umbrella (depending on the size of your umbrella).
- 4. FREE STANDING STEEL FRAME** - You may opt to use a free standing base for your Orion umbrella. We recommend a minimum of a 350-500lbs. base weight for this umbrella (depending on the size of your umbrella). **NOTE:** If using a free-standing steel frame, wind guidelines change from light to moderate winds to light winds only.

**NOTE: REFER TO BASE WEIGHT MATRIX AND SEPARATE MANUAL FOR BASE ASSEMBLY PRIOR TO PROCEEDING.**

## ASSEMBLY INSTRUCTIONS

**Two-person team is recommended for assembly.**

By now, you have installed your mount kit, SM PLATE onto your steel base weight, or have set up your steel base frame with recommended base weight.

Unpack the Orion and lay it out on a clean, soft surface. Slide the boom over the elbow and secure with supplied fastening screws. **Note:** Be careful to not knick the cord.



### Installing Internal Stem

**Option A: If you wish to use optional internal stem cover, proceed below. Otherwise, if you wish to not use cover and for a quicker installation, skip to Option B on page 6.**

Remove internal stem from bottom of mast by removing the three bolts underneath the turning handle. **Note:** Do not remove the bolt above the turning handle! Install internal stem onto mount kit, SM PLATE or steel base frame with supplied 5 bolts and washers using allen wrench. *Do not completely tighten.* **Note:** Do not use power drill. May cause damage to umbrella.



*(Astral-TC Internal Stem shown)*

Slide internal stem cover over bottom of Orion mast. Using a two person team, lift umbrella with cover and insert bottom of mast onto internal stem. Tighten 5 bolts to secure umbrella in place with allen wrench. **Note:** Do not use power drill. May cause damage to umbrella. Slide internal stem cover down to cover internal stem.



*(Astral-TC Internal Stem shown)*

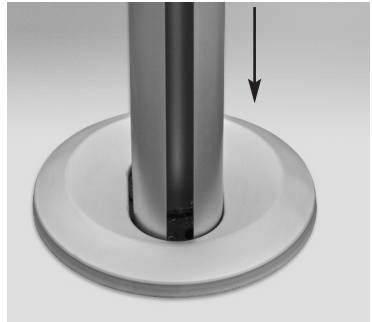

Internal Mast Stem Cover Installed

### Attaching Orion to Internal Stem

Lift rotating handle from mast. Rotate Orion mast until the bore holes for the locking screws in the internal stem line up in the mast. Tighten locking screws with allen wrench into the mast and internal stem to secure. **Note:** Do not use power drill. May cause damage to umbrella. Once complete, proceed to “Leveling Umbrella” on page 7.

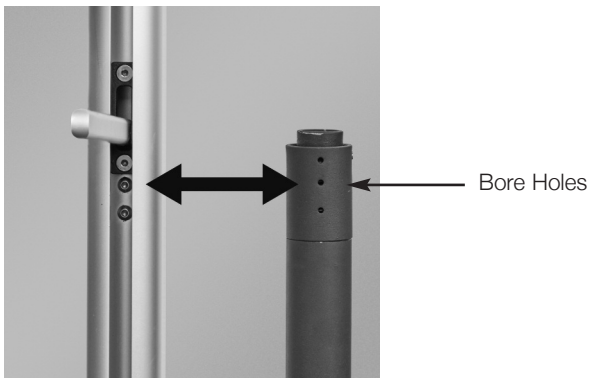

**Option B: If you wish not to use optional internal stem cover, proceed below.**

Using a two person team, lift umbrella with attached internal stem and install umbrella onto mount kit, SM PLATE on your steel base weight. Tighten 5 bolts to secure umbrella in place with allen wrench. Once complete, proceed below.



*(Astral-TC Internal Stem shown)*

---

### **Leveling Umbrella**

Check the vertical position of the umbrella with a level tool.



If the umbrella is not level, lift optional internal stem cover to access internal stem. Untighten the 5 bolts with 1-2 rotations (do not completely untighten bolts!). The internal stem can rotate without applying force. Correct the vertical level position with leveling screws.



Once leveled, re-tighten the 5 bolts with allen wrench on internal stem. **Note:** Do not use power drill. May cause damage to umbrella. Slide optional internal stem cover down and cover internal stem.



## Attaching Canopy Structure to Head Fitting

Lift canopy structure and connect sister clip on the canopy structure to the clip on the stainless wire. Slide the canopy structure into the head fitting by aligning the set screw on the top of the canopy structure with the slot in the head fitting. May need to loosen cord. Turn 90° and secure. Gently lower canopy structure until set screw latches.



Sister Clips

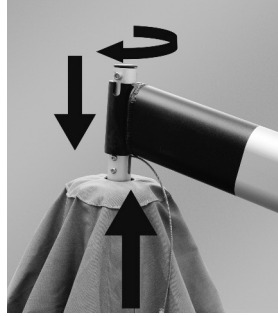

*You are now ready to operate your umbrella!*

## OPERATING INSTRUCTIONS

Remove all packaging from umbrella.

### To Open Canopy

1. Undo the strap and slightly loosen arms.  
**CAUTION:** NEVER FORCE THE ARMS. If you experience any resistance, make sure all arms are freed manually to facilitate opening.



2. Once the arms have been freed manually, insert crank handle into gear.
3. Turn crank handle clockwise until the canopy is taut.

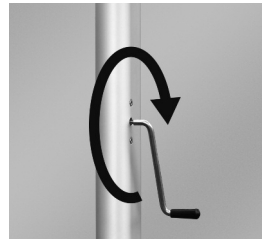

### To Rotate 360°

1. There are (8) 45° locking rotating positions. Raise the turning handle above 90° and rotate mast to one of the 8 preset positions.
2. Lower handle to lock into place.

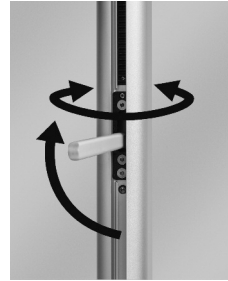

### To Close Canopy

1. Turn crank handle counter-clockwise and continue winding until canopy is lowered, strap canopy.



### To Properly Remove Canopy Structure

1. Lower the canopy to the closed position.
2. Disconnect sister clips on canopy structure from the clip on stainless wire.
3. Turn canopy structure 90° and slide out of head fitting.
4. Store away canopy structure.
5. Secure loose end of sister clip to sister clip safety stud.

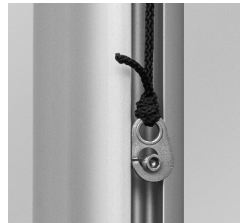
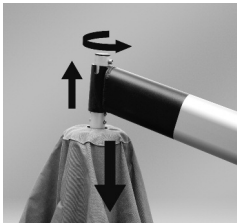

Sister Clip on Safety Stud

---

## LIGHT ADAPTER

To open light adapter:

Loosen light adapter built into the umbrella runner by turning counter-clockwise. After loosening, pull down light adapter post and attach umbrella light (sold separately).

To close light adapter:

Gently push up the light adapter post back into umbrella runner and tighten turning clockwise **NOTE:** It is not necessary to remove light to close umbrella.



## TO PROPERLY FOLD CANOPY

The 100% solution dyed canopy will last longer if you fold it as it was packed and shipped. This technique is similar to the way a parachute is folded and is especially important when folding the canopy for seasonal storage or when left in the closed position for an extended period of time.

Using this technique at all times will significantly extend the life of the canopy.

1. When the canopy has been fully lowered, stand in front of the canopy structure and begin the folding process by pulling out two panels opposite the mast. Pull the two panels together and roll tight into the canopy.
2. Once rolled tight, pull adjacent panels out one at a time and fold to the center, alternating sides until all the panels have been pulled out from the arms and folded into the center.
3. Wrap and secure strap around the canopy.

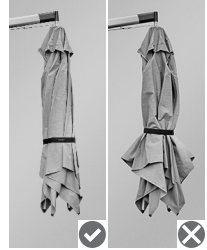

## PROTECTIVE COVER

1. Screw rods together and insert into slit of the cover.
2. Unzip cover.
3. Using the rod as a guide, slide cover over your umbrella.
4. Attach rod with key ring to the zipper.
5. Pull on string to zip down your cover and tie.



## MAINTAINING FRAME & FITTINGS

1. Hose frame with water periodically, more often if installation is in a salty or industrial environment.
2. Inspect the installation fitting, mount bolts, rib spacers, etc. on a regular basis and tighten if necessary.

## MAINTAINING CANOPY FABRIC

1. Clean up spills and stains right away. Spills can be removed by using a clean absorbent cloth.
2. For general maintenance, use a soft brush to remove dust and dry soil. Wash down with clean, warm water (i.e., garden hose) every so often to avoid dirt becoming ingrained. Allow the fabric to air dry before closing the canopy.
3. If a thorough cleaning is necessary, sponge over the fabric using a mild soap solution (2% solution). Rinse well with plenty of water to remove all soap residue.
4. Never use detergents, cleaning fluids or solvents. Grease and oil stains may be removed by using turpentine or similar with an absorbent cloth.
5. Please visit the fabric websites for more details: [www.shademakerusa.com](http://www.shademakerusa.com) or [www.sunbrella.com](http://www.sunbrella.com)
6. Use protective canopy cover during storage or when not in use.

## REMOVAL & REPLACEMENT OF CANOPY

Follow these instructions should you choose to replace your canopy with a new canopy.

1. Lower the canopy to the closed position.
2. Remove canopy structure from head fitting. Disconnect sister clip.
3. Velcro at connection of main arm.
4. Remove the button/screw at the end of each arm.
5. Remove the canopy from the structure.
6. To replace the canopy, reverse the above process.

# **shademaker**

architectural shade

13401 Brooks Drive  
Baldwin Park, CA 91706  
p 626.338.8810  
f 626.338.8816  
info@shademakerusa.com

**shademakerusa.com**